

TOP MOUNT TOP CLOSED - LIGHT

13501111010

13502111010

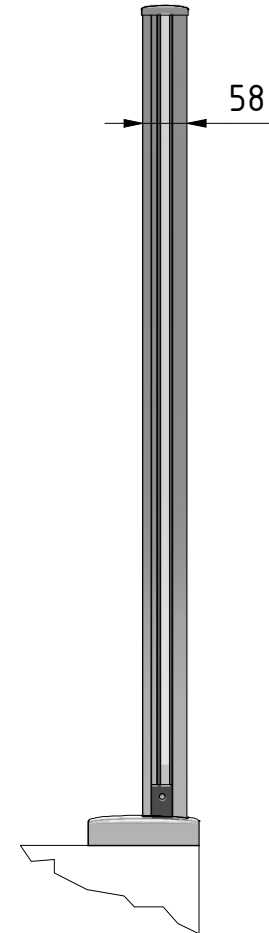
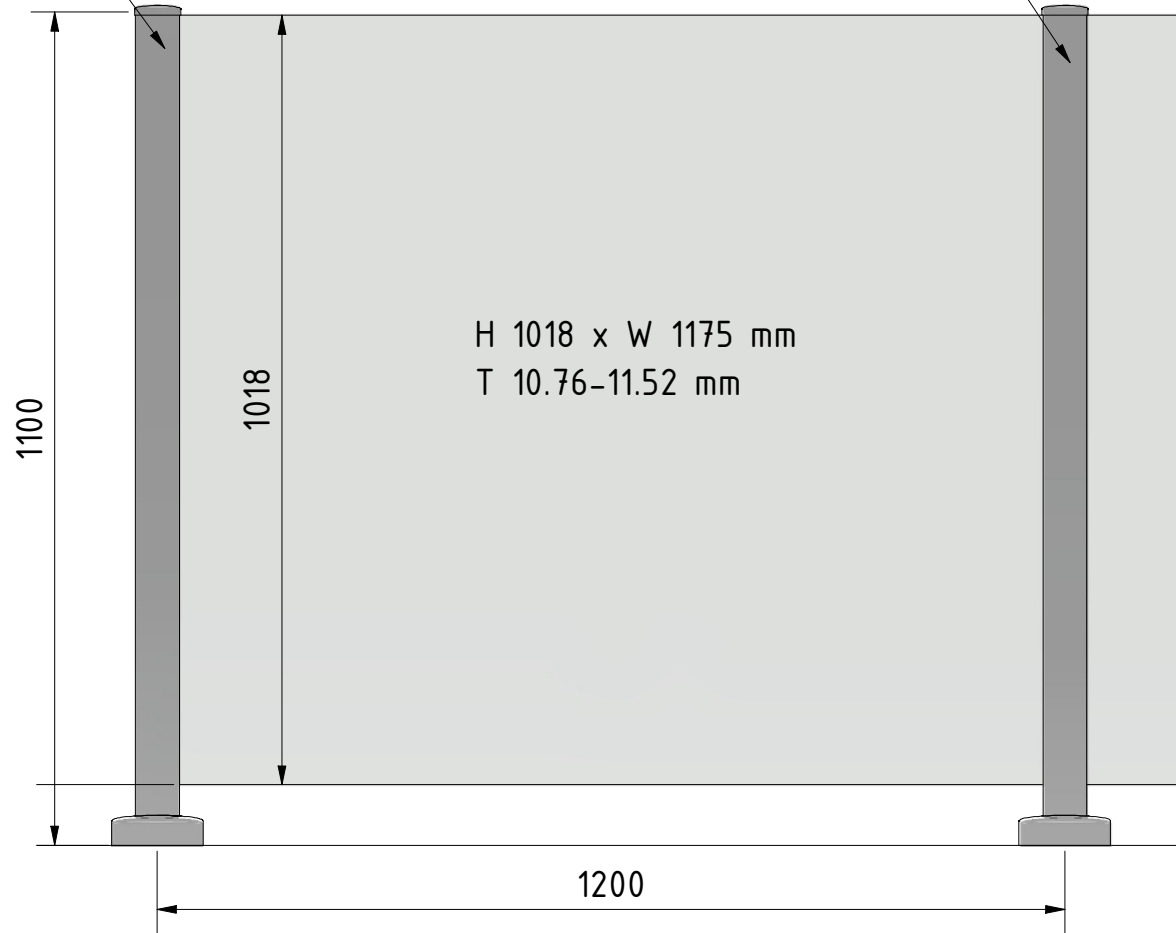

TOP MOUNT INSTALLATION (SIDE/MID POST TOP CLOSED)

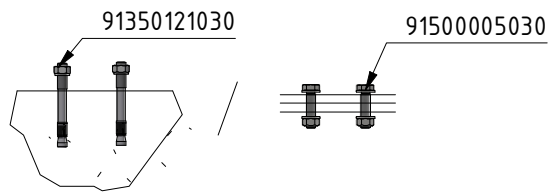
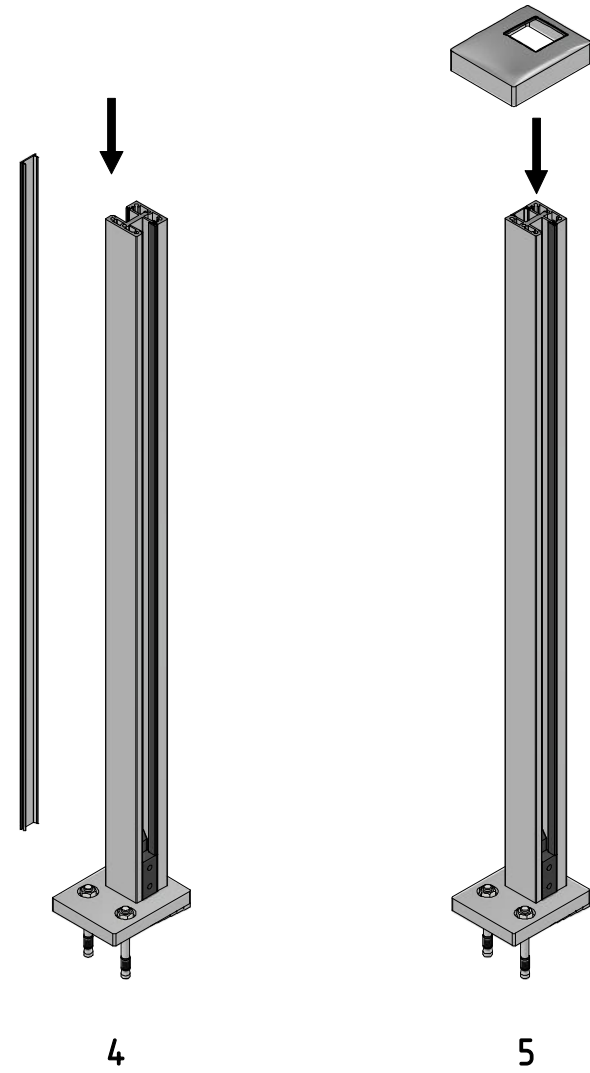
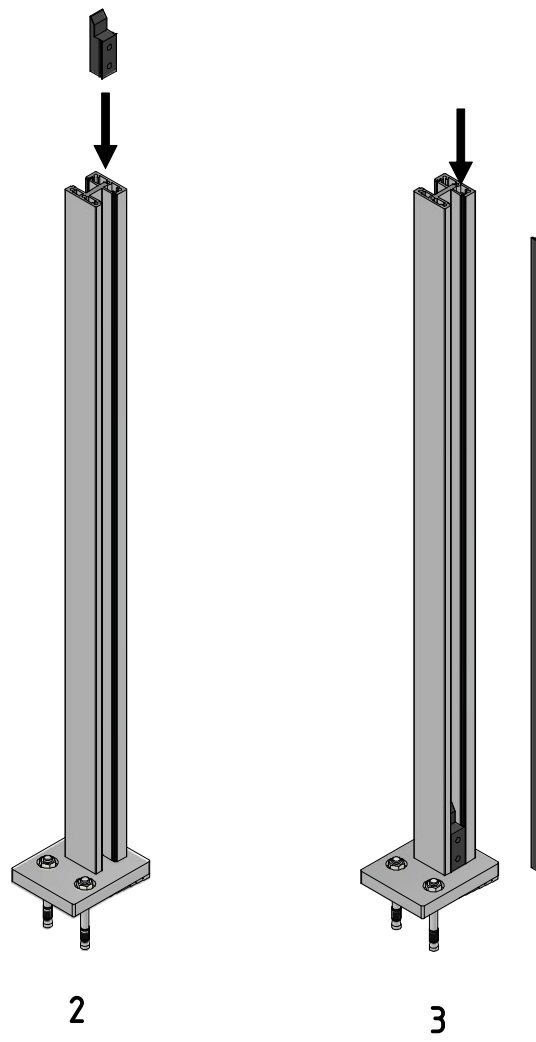
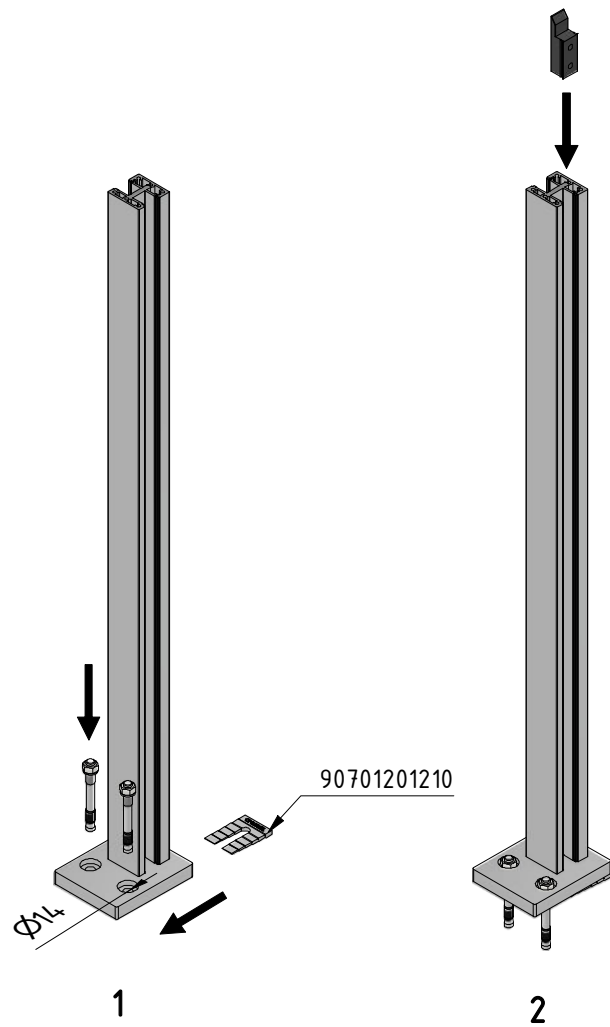

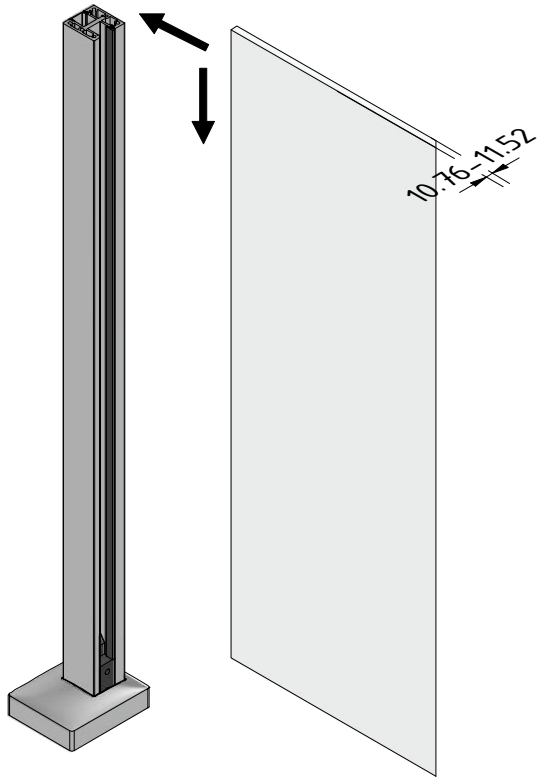

6

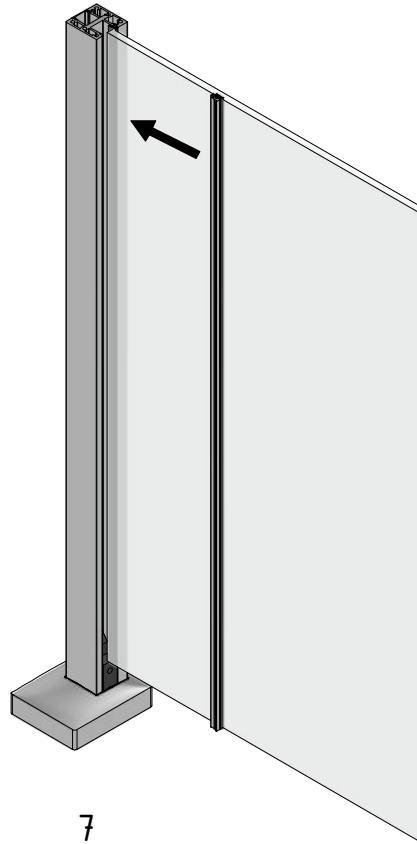

7

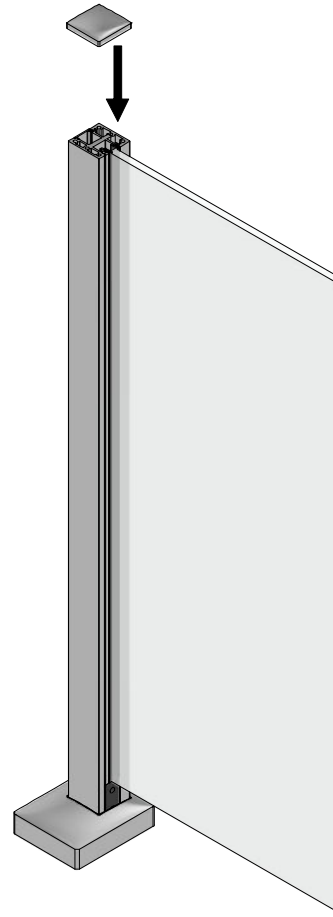

8

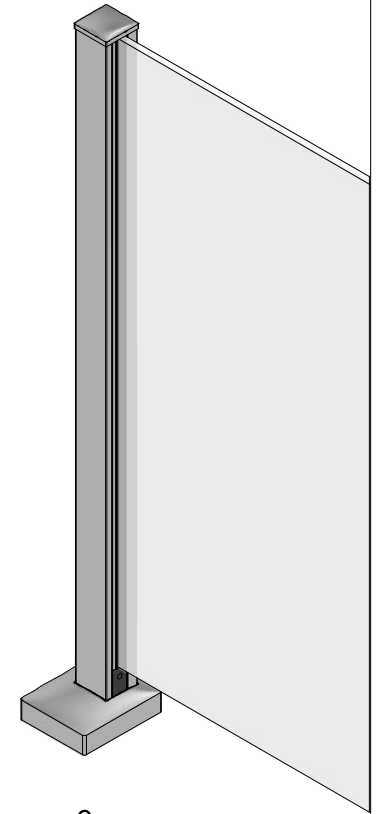

9

TOP MOUNT INSTALLATION (CORNER POST TOP CLOSED)

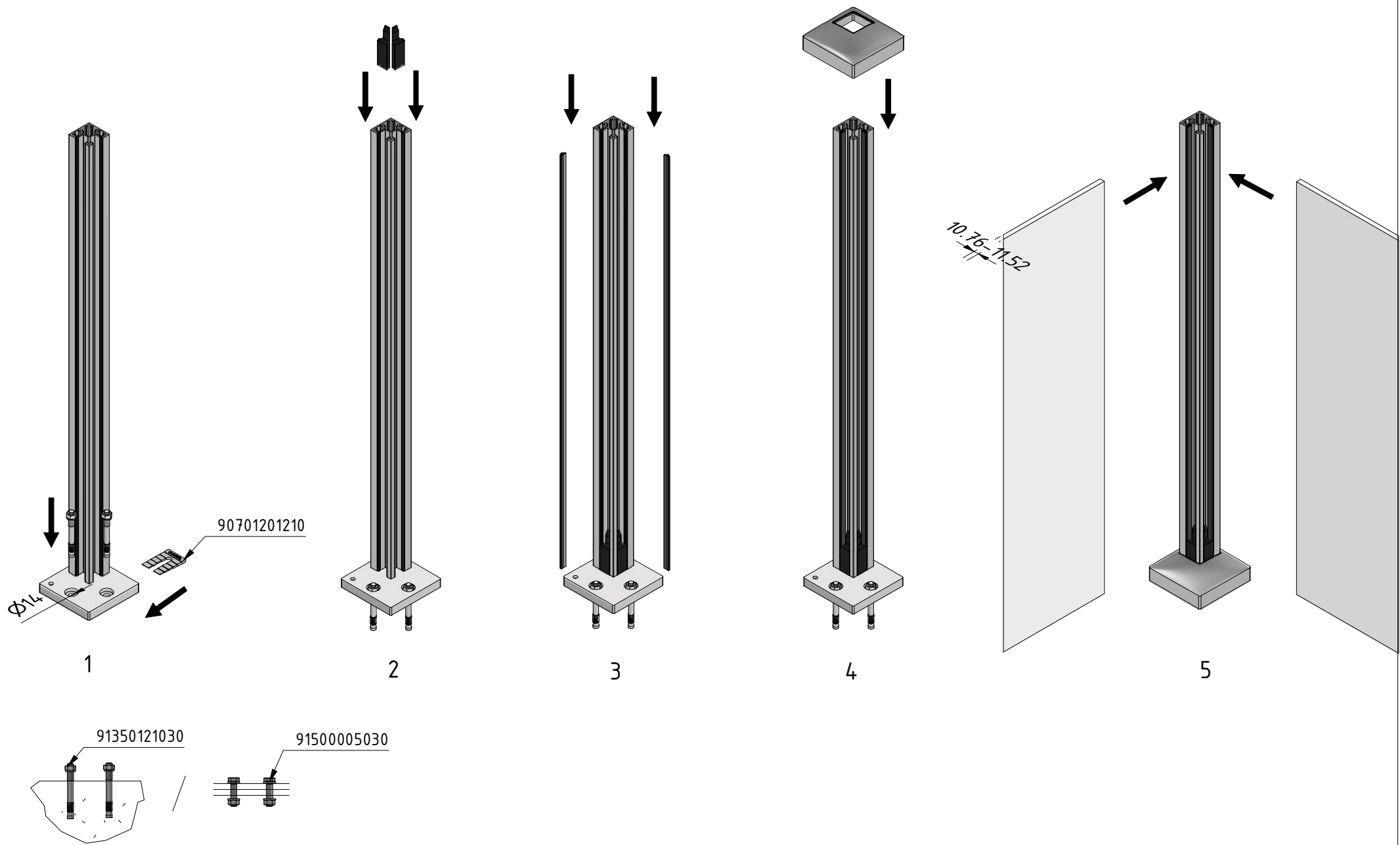

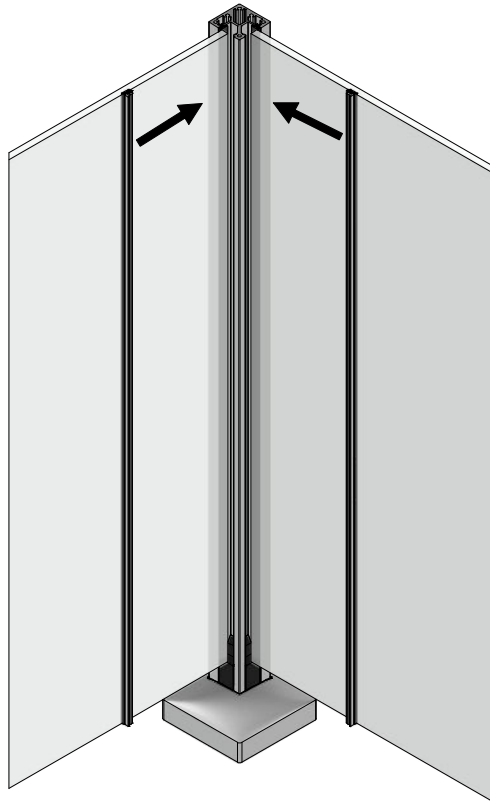

6

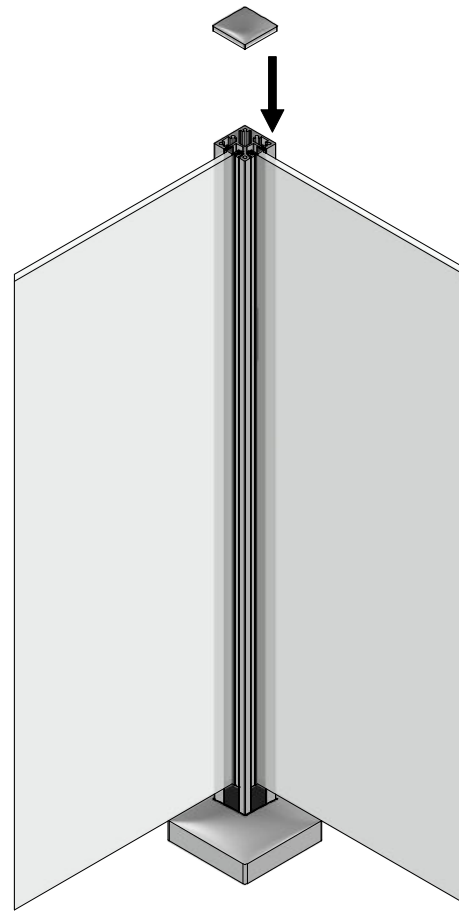

7

13503111010

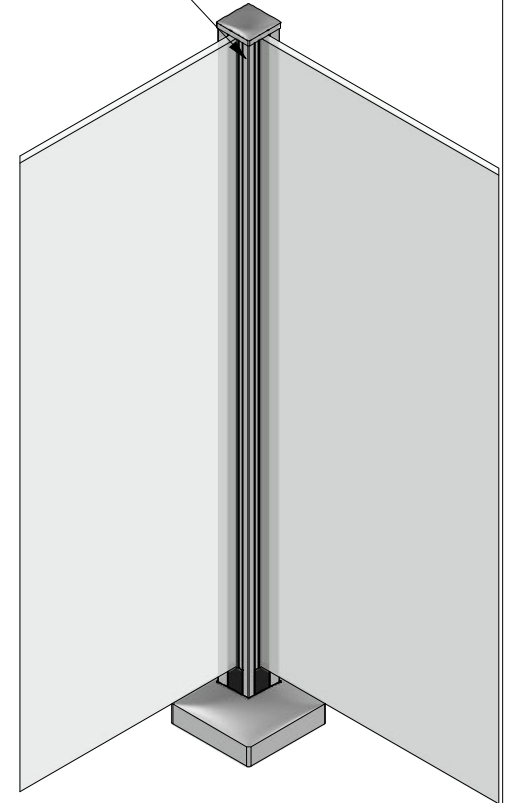

8