

ONLEVEL



TL60**80** - TL60**81**  
SYSTEMS FOR FRAMELESS  
ALL-GLASS BALUSTRADES





Extra low profile height  
of only 125 mm

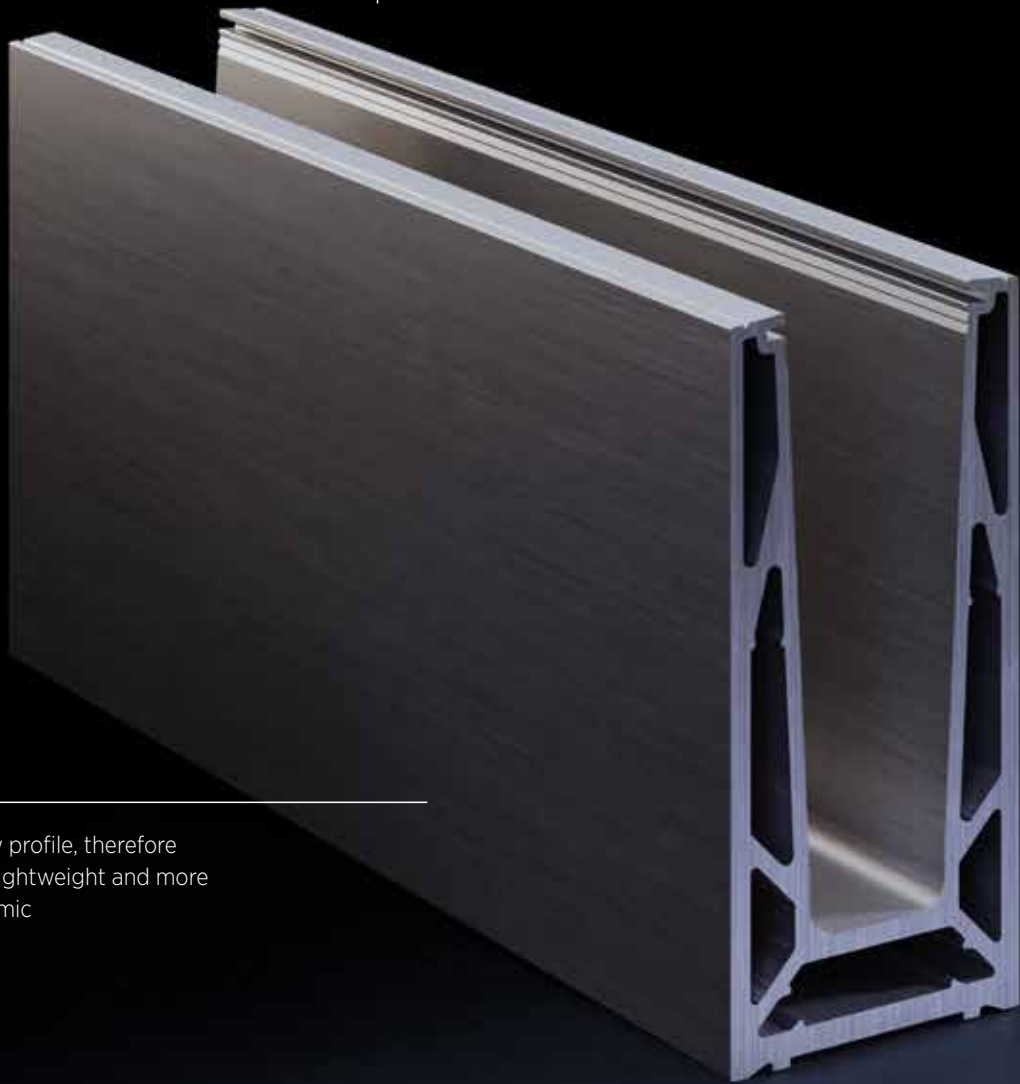

Hollow profile, therefore  
more lightweight and more  
economic



Top mount



# TL-6080 | 1.0 KN TOP MOUNT

## Glass profile



| Height: 125 mm  
| Width: 60 mm  
| Sales unit: 1 piece

Model 6080	Mill finish	Plain aluminium	RAL coloured
Length	Art. no.	Art. no.	Art. no.
5000	10.6080.005.10	10.6080.005.11	10.6080.005.13/16/18/19

## Inside corner / outside corner 90°



| Side length inside: 140 mm  
| Side length outside: 200 mm  
| Sales unit: 1 piece

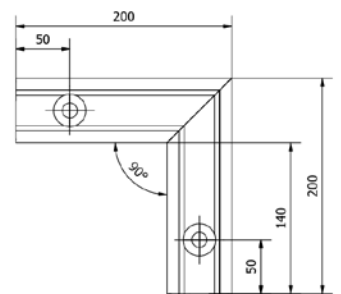

Model 6080	Mill finish	Plain aluminium	RAL coloured
	Art. no.	Art. no.	Art. no.
	10.6080.390.10	10.6080.390.11	10.6080.390.13/16/18/19

## End cap, left/right



| For use on the left and right  
| Sales unit: 1 piece

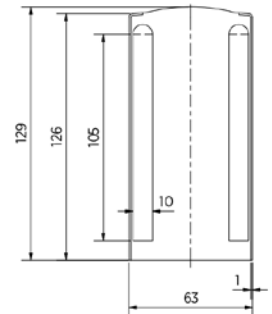

Model 6080	Mill finish	Plain aluminium	RAL coloured
Application	Art. no.	Art. no.	Art. no.
left/right	10.6080.490.10	10.6080.490.11	10.6080.490.13/16/18/19

## Fischer fixing anchor FH II 12/10



| Finish interior application: zinc-plated steel (inside)  
| Finish exterior application: V4A (exterior)  
| Required number per 5000mm: 20 pieces  
| Sales unit: 50 pieces

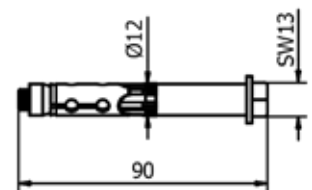

Model 3521	zinc-plated steel (inside)	AISI 316 (exterior)
	Art. no.	Art. no.
	91.3521.210.81	91.3521.210.30

# TL-6080 | 1.0 KN TOP MOUNT

## Fischer fixing anchor FIS A M12x120



- | Suitable mortar: 91.3000.010.00
- | V4A (outside)
- | Required number per 5000mm: 20 pieces
- | Sales unit = 10 pieces

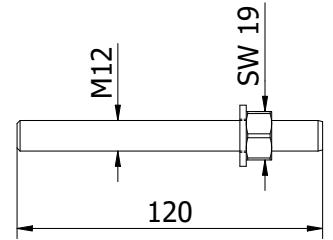

Model 3551	V4A (outside)
Art. no.	
91.3551.212.30	

## Onlevel fixing anchor SZ-S 12-10



- | Finish interior application: zinc-plated steel (interior)
- | Finish exterior application: V4A (outside)
- | Required number per 5000mm: 20 pieces
- | Sales unit: 50 pieces

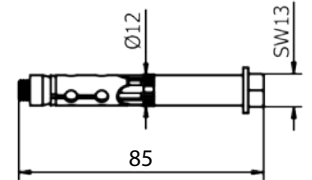

Model 3621	zinc-plated steel (interior)	V4A (outside)
Art. no.		Art. no.
91.3621.210.81		91.3621.210.30

## Mounting set for steel



- | Finish interior application: zinc-plated steel (inside)
- | Finish exterior application: V4A (exterior)
- | Required number per 5000 mm: 20 pieces
- | M12 x 40 mm
- | Sales unit: 9 piece

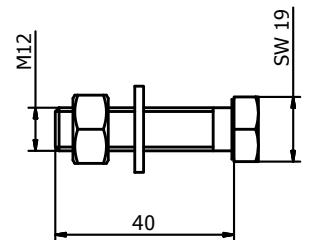

Model 6080	zinc-plated steel (inside)	AISI 316 (exterior)
Art. no.		Art. no.
91.6080.040.81		91.6080.040.30

## FLEXFIT 1.0 KN



Length		2500 mm	5000 mm	25 mtr
Glass thickness	Wedge colour	Art. no.	Art. no.	Art. no.
12 mm	black	-	90.0505.112.00	-
6/6/2 (12,76 mm)	red	90.0502.113.00	90.0505.113.00	90.0525.113.00
6/6/4 (13,52 mm)	grau	-	90.0505.114.00	-
<b>8/8/2 (16,76 mm)</b>	red	90.0502.117.00	90.0505.117.00	90.0525.117.00
<b>8/8/4 (17,52 mm)</b>	green	90.0502.118.00	90.0505.118.00	90.0525.118.00
<b>10/10/2 (20,76 mm)</b>	red	90.0502.121.00	90.0505.121.00	90.0525.121.00
<b>10/10/4 (21,52 mm)</b>	green	90.0502.122.00	90.0505.122.00	90.0525.122.00

# TL-6081

1.0 kN Side Mount

## Glass profile with slim hips.

The TL-6081 U Profile is the intelligent onward development of the TL-6021 Profile. It is much slimmer and stands out due to its extra low profile height of only 125 mm. What is so special about it is the fact that the mounting distances have been increased. That makes the product much faster and cheaper to mount.

As a matter of fact, the profile is suited both for interior and exterior applications. It can withstand a linear load of up to 1.0 kN and is appropriate for glass thicknesses between 12 mm and 21.52 mm.

## Essential Features

- | Slimline, elegant design and low-maintenance
- | ONLEVEL FLEXFIT Glass Adjustment Tool
- | Drainage holes
- | Cover (optional)
- | For use with 3.0 kN Top Cover
- | Extra low profile height of only 125 mm
- | For glass thicknesses between 12 mm and 21.52 mm

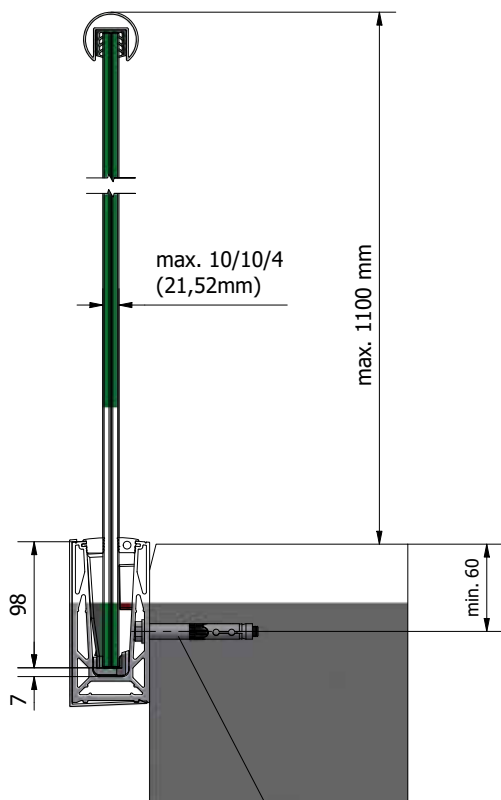

Indoor: 91.3521.210.81  
Outdoor: 91.3521.210.30  
(20x/5m)

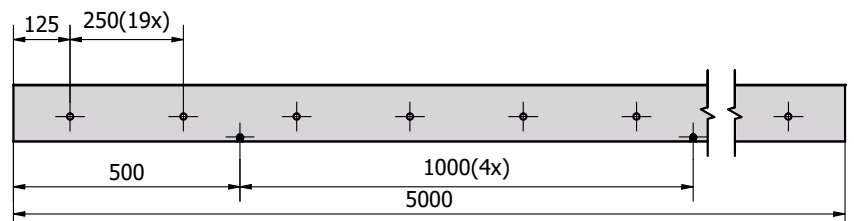
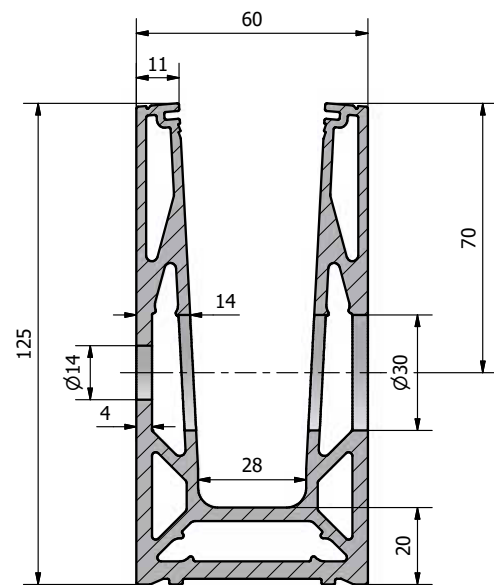



Extra low profile height  
of only 125 mm



Side mount

Integrated multifunctional  
sophisticated chamber for  
enabling larger drilling distances

# TL-6080 | 1.0 KN TOP MOUNT

## Glass profile



| Height: 125 mm  
| Width 60 mm  
| Sales unit: 1 piece

Model 6081	Mill finish	Plain aluminium	RAL coloured
Length	Art. no.	Art. no.	Art. no.
5000	10.6081.005.10	10.6081.005.11	10.6081.005.13/16/18/19

## Inside corner 90°



| Side length inside: 140 mm  
| Side length outside: 200 mm  
| Sales unit: 1 piece

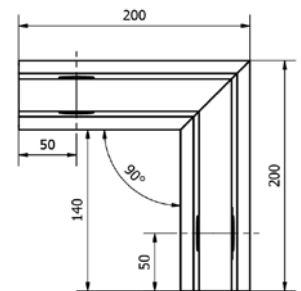

Model 6081	Mill finish	Plain aluminium	RAL coloured
	Art. no.	Art. no.	Art. no.
	10.6081.300.10	10.6081.300.11	10.6081.300.13/16/18/19

## Outside corner 90°



| Side length inside: 140 mm  
| Side length outside: 200 mm  
| Sales unit: 1 piece

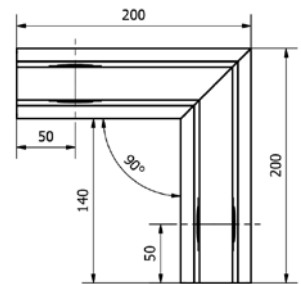

Model 6081	Mill finish	Plain aluminium	RAL coloured
	Art. no.	Art. no.	Art. no.
	10.6081.350.10	10.6081.350.11	10.6081.350.13/16/18/19

## Snapframe



| With mounting strips  
| For use with a cover cap, end caps must be ordered separately.  
| Sales unit: 1 piece

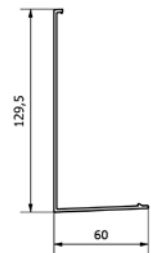

Model 6081	Mill finish	Plain aluminium	RAL coloured
Length	Art. no.	Art. no.	Art. no.
5000	10.6081.205.10	10.6081.205.11	10.6081.205.13/16/18/19



# TL-6080 | 1.0 KN TOP MOUNT

## End cap without Snapframe, left



| For use on the left  
| Sales unit: 1 piece

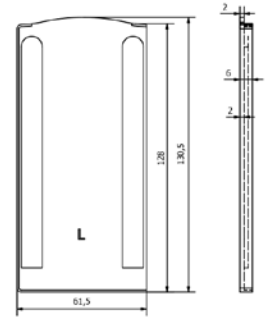

Model 6081	Mill finish	Plain aluminium	RAL coloured
Application	Art. no.	Art. no.	Art. no.
left	10.6081.400.10	10.6081.400.11	10.6081.400.13/16/18/19

## End cap without Snapframe, right



| For use on the right  
| Sales unit: 1 piece

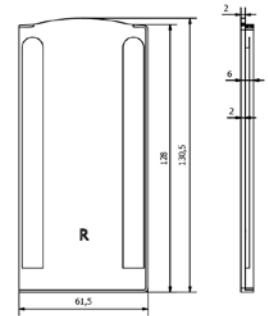

Model 6081	Mill finish	Plain aluminium	RAL coloured
Application	Art. no.	Art. no.	Art. no.
right	10.6081.450.10	10.6081.450.11	10.6081.450.13/16/18/19

## End cap with Snapframe, left



| For use on the left  
| Sales unit: 1 piece

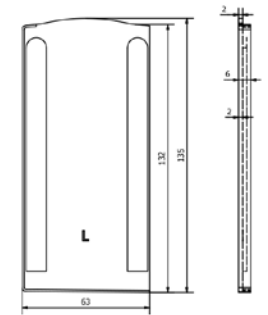

Model 6081	Mill finish	Plain aluminium	RAL coloured
Application	Art. no.	Art. no.	Art. no.
left	10.6081.410.10	10.6081.410.11	10.6081.410.13/16/18/19

## End cap with Snapframe, right



| For use on the right  
| Sales unit: 1 piece

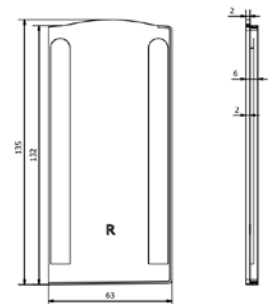

Model 6081	Mill finish	Plain aluminium	RAL coloured
Application	Art. no.	Art. no.	Art. no.
right	10.6081.460.10	10.6081.460.11	10.6081.460.13/16/18/19

# TL-6080 | 1.0 KN TOP MOUNT

## Blanking plug



| Required number per 5000 mm: 20 pieces  
| Sales unit: 10 pieces

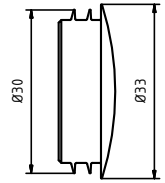

Model 7000		Plastic
Colour	Diameter	Art. no.
white	30 mm	90.7000.030.40
black	30 mm	90.7000.030.41
grey	30 mm	90.7000.030.45

## Extension pin



| Length: 40 mm  
| Diameter: Ø 6 mm  
| Sales unit: 8 pieces

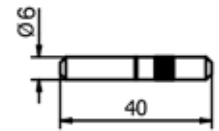

Model 7001	AISI 316 (inside & outside)
Art. no.	
	90.7001.640.31

## Fischer fixing anchor FH II 12/10



| Finish interior application: zinc-plated steel (inside)  
| Finish exterior application: V4A (exterior)  
| Required number per 5000mm: 20 pieces  
| Sales unit: 50 pieces

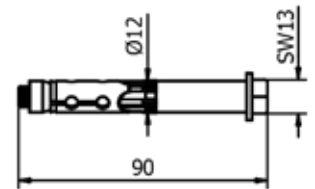

Model 3521	zinc-plated steel (inside)	AISI 316 (exterior)
Art. no.		Art. no.
	91.3521.210.81	91.3521.210.30

## Onlevel fixing anchor SZ-S 12-10



| Finish interior application: zinc-plated steel (interior)  
| Finish exterior application: V4A (outside)  
| Required number per 5000mm: 20 pieces  
| Sales unit: 50 pieces

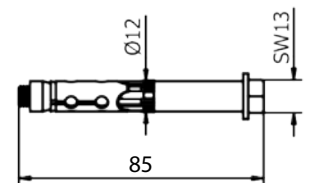

Model 3621	zinc-plated steel (interior)	V4A (outside)
Art. no.		Art. no.
	91.3621.210.81	91.3621.210.30

# TL-6080 | 1.0 KN TOP MOUNT

## Mounting set for steel



- | Finish interior application: zinc-plated steel (inside)
- | Finish exterior application: V4A (exterior)
- | Required number per 5000 mm: 20 pieces
- | M12 x 40 mm
- | Sales unit: 9 piece

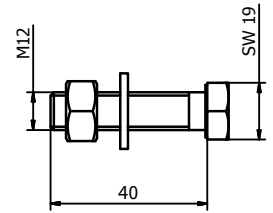

Model 6081	zinc-plated steel (inside)	AISI 316 (exterior)
	Art. no.	Art. no.
	91.6081.040.81	91.6081.040.30

## FLEXFIT 1.0 KN



- | Fine adjustment of glass panes
- | For glass thicknesses between 12 - 21.52 mm
- | Adjustment of up to 34 mm in relation to the vertical axis
- | Pay attention to the right glass thickness!

Length		2500 mm	5000 mm	25 mtr
Glass thickness	Wedge colour	Art. no.	Art. no.	Art. no.
12 mm	black	-	90.0505.112.00	-
6/6/2 (12,76 mm)	red	90.0502.113.00	90.0505.113.00	90.0525.113.00
6/6/4 (13,52 mm)	grau	-	90.0505.114.00	-
<b>8/8/2 (16,76 mm)</b>	red	90.0502.117.00	90.0505.117.00	90.0525.117.00
<b>8/8/4 (17,52 mm)</b>	green	90.0502.118.00	90.0505.118.00	90.0525.118.00
<b>10/10/2 (20,76 mm)</b>	red	90.0502.121.00	90.0505.121.00	90.0525.121.00
<b>10/10/4 (21,52 mm)</b>	green	90.0502.122.00	90.0505.122.00	90.0525.122.00



ONLEVEL

**ONLEVEL GmbH** | Budberger Straße 5 | 46446 Emmerich am Rhein | Germany  
+49 (0)2822 97514-0 | [info@onlevel.com](mailto:info@onlevel.com) | [www.onlevel.com](http://www.onlevel.com)